



|     |                          |
|-----|--------------------------|
| 496 | Fittings for glass doors |
| 504 | Glass-door boxes         |
| 513 | Glass-door hinges        |
| 516 | Doorknobs                |
| 518 | Sliding door handles     |
| 519 | Door holders             |
| 521 | Technical information    |

# Fittings for glass doors

## Added value at a glance

Glass has always been a versatile architectural material, and glass doors carry this role into the sphere of interior design. Sliding glass doors also make efficient use of space and open up smaller rooms. FSB offers a range of glass door fittings that are compelling both in their contributions to design and to function.

Acoustically attenuated latch bolt in a combination of plastic/pressure die casting

Diverse materials and finishes in aluminium, stainless steel and bronze

Integrated in existing handle ranges for continuity of design and use of materials

Heavy-duty glass door lock DIN 18250 and 18251 based on grade 4

Pared-down dimensioning of the lock cover



---

Fittings with consistent design for glass doors in combination with doorknobs, sliding door handles and hinges

---

Pre-fitted for glass thicknesses 8 and 10 mm



---

Can be combined with over 50 different door handle models



---

Variants for emergency exit devices conforming to EN 179 available with APD or APE panic function

---

Fire safety variants conforming to DIN 18273 available for tempered safety glass (10 and 24 mm)

---

Variants with or without round/square handle rose; alternatively also with CH-RC round cylinder keyway

# Fittings for glass doors

## Product variants

### Product features of glass door fittings

Our glass-door boxes can be combined with almost any FSB door handle model and are available with or without profile cylinder (PC) keyway. Please specify when ordering:

- Door handle model
- DIN door handing

In addition to glass-door boxes, the following pages also present matching strike boxes, door hinges and a door holder.

---

#### Standard variant Glass door fitting 13 4231



Illustrative example featuring door handle 1244

13 4231 can be combined with:

- ☞ Door handles without handle roses

Cannot be combined with models 1163, 1241, 1242, 1251 and 1254

#### Standard variant Glass door fitting 13 4224



Illustrative example featuring door handle 1244

13 4224 can be combined with:

- ☞ Door handles without handle roses

Teflon-coated bushing with handle guide, which can withstand the mechanical forces exerted on large-format glass doors even though the glass door fitting is smaller and more discreet than models 13 4220 and 13 4223

#### Heavy-duty variant Glass door fitting 13 4223



Illustrative example featuring door handle 1244 and handle roses

13 4223 can be combined with:

- ☞ Door handles without handle roses
- ☞ Door handles with handle roses and FSB ASL® bearing (see page 56 f.) for light to medium heavy-duty doors
- ☞ Door handles with handle roses and FSB AGL® heavy-duty bearing (see page 58 f.) for heavy-duty and high-traffic doors

**Heavy-duty variant**  
**Glass door fitting 13 4220**

**Fire safety and EN 179 variant**  
**Glass door fitting 13 4220 090**

**Other fittings for glass doors**



Illustrative example featuring door handle 1244 and handle roses



Illustrative example featuring door handle 1244 and handle roses

The range would not be complete without doorknobs and flush pulls for glass doors. Furthermore, all door pulls (except push/pull pad handles) and individually configurable pull handle systems can also be installed on glass doors with the right fixing set (see page 630 ff.).

If desired, glass door fittings from series 13 4220 04.../05..., 13 4223 and 13 4224 and their companion door handles can be powder-coated in any colour from the RAL colour chart to match the interior design concept.

13 4220 can be combined with:

- ☞ Door handles without handle roses
- ☞ Door handles with handle roses and FSB ASL® bearing (see page 56 f.) for light to medium heavy-duty doors
- ☞ Door handles with handle roses and FSB AGL® heavy-duty bearing (see page 58 f.) for heavy-duty and high-traffic doors

13 4220 090 can be combined with:

- ☞ Door handles with handle roses and FSB AGL® FS heavy-duty bearing (see page 58 f.) for heavy-duty and high-traffic doors in fire safety variant
- ☞ Door handles with handle roses and FSB AGL® FS heavy-duty bearing (see page 58 f.) for heavy-duty and high-traffic doors for emergency exit devices in fire safety variant conforming to EN 179

6d

# Fittings for glass doors

## Overview

---

### Glass-door boxes

13 4224   
Page 504 f.



---

13 4220   
Page 506 f.



---

13 4223   
Page 509 f.



---

13 4231   
Page 511 f.



**Glass-door hinges**

13 4228 ■ ■ ■  
Page 514



13 4227 ■ ■ ■  
Page 515



13 4232 ■ ■ ■  
Page 513



**Doorknobs**

23 0802 ■ ■ ■ ■  
Page 516

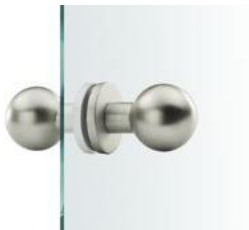

23 0828 ■ ■ ■  
Page 517



23 0829 ■ ■ ■ ■  
Page 517



23 0844 ■ ■ ■  
Page 516

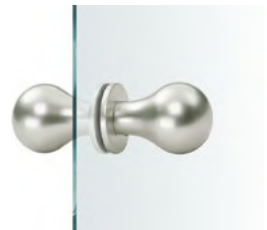

6d

**Sliding door handles**

13 4256 ■ ■ ■  
Page 518



13 4256 ■ ■ ■  
Page 518



13 4257 ■ ■ ■  
Page 519



**Door holders**

13 4230 ■ ■  
Page 519





# Fittings for glass doors

## Compact glass-door box

■ Aluminium  
■ Stainless steel  
■ Bronze



13 4224 ■ ■

↻ 13 4224 042 (R) | 13 4224 052 (L)

Compact rectangular glass door fitting with heavy-duty glass door lock (DIN 18251-1, grade 4)

Profile cylinder (PC) 72 mm, 8 mm self-tightening follower in steel with polyamide retaining ring

Latch bolt in a combination of plastic/pressure die casting, acoustically attenuated

Bolt head as bright nickel-plated casting; bearing with Teflon-coated bushing that wholly envelops the handle neck; can be combined with female handles

Pictured: DIN RH, opening inwards

The glass door fitting, developed in collaboration with Ingenhoven Architects, stands out for its pared-down design without handle roses, its extremely compact dimensions and the fact that it can be flush-fitted with the door frame (when using DIN frames). The fitting closes flush with DIN frame so that the door frame and fitting join together as one visual unit. Particularly delightful when combined with door handle 1078: the dividing line on the grip section aligns perfectly with the edge of the glass door fitting.

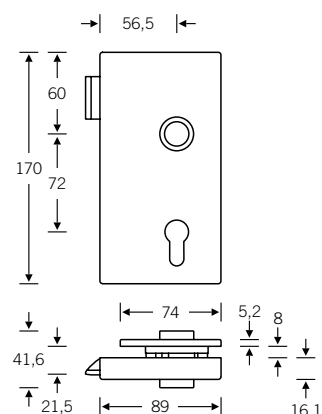

Please specify DIN door handing when ordering

- ↻ Female handles
  - ↻ FSB ASL®
  - ↻ FSB AGL®
  - ↻ FS heavy-duty fitting
  - ↻ EN 179 heavy-duty fitting
- For bearings, see page 52 ff.

# Fittings for glass doors

## Compact strike box

- Aluminium
- Stainless steel
- Bronze



13 4224

13 4224 045 (R) | 13 4224 055 (L)

Compact rectangular strike box  
for double-leaf glass doors  
matching glass door fitting  
13 4224 042 (R) | 13 4224 052 (L)

Pictured: DIN LH, opening inwards

6d

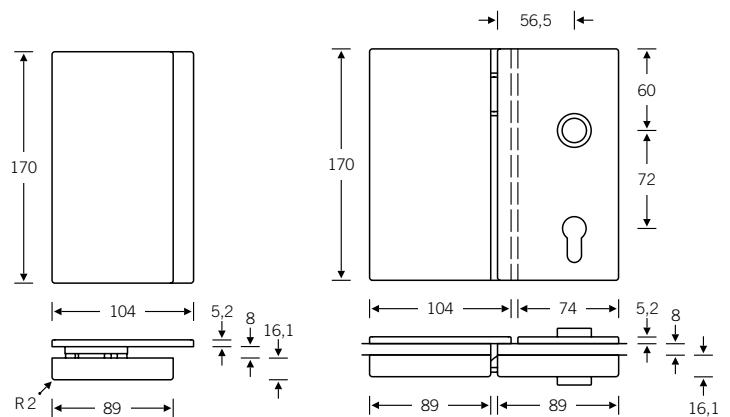

Please specify DIN door handing when ordering

- Female handles
  - FSB ASL®
  - FSB AGL®
  - FS heavy-duty fitting
  - EN 179 heavy-duty fitting
- For bearings, see page 52 ff.

# Fittings for glass doors

## Glass-door boxes

- Aluminium
- Stainless steel
- Bronze



Model 13 4220 041



Model 13 4220 042

13 4220

- ⊖ 13 4220 041 (R) | 13 4220 051 (L)
- ⊕ 13 4220 042 (R) | 13 4220 052 (L)\*
- ⊖ 13 4220 042 (R) | 13 4220 052 (L)\*

Rectangular glass door fitting with heavy-duty glass door lock (DIN 18251-1, based on grade 4)

Profile cylinder (PC) 72 mm, 8 mm self-tightening follower in steel with polyamide retaining ring

Latch bolt in a combination of plastic/pressure die casting, acoustically attenuated

13 4220 041 (R) | 13 4220 051 (L)  
Fitted for profile cylinder (PC); bolt head as bright nickel-plated casting; handle bushing in GFR polyamide; can be combined with female handles

13 4220 042 (R) | 13 4220 052 (L)  
Fitted for profile cylinder (PC) with lifter assembly; bolt head as bright nickel-plated casting; pre-fitted for installation of door handles with handle roses and FSB ASL® bearing or FSB heavy-duty fitting with FSB AGL® bearing (also available in these two variants with square handle roses)

Pictured: DIN RH, opening inwards

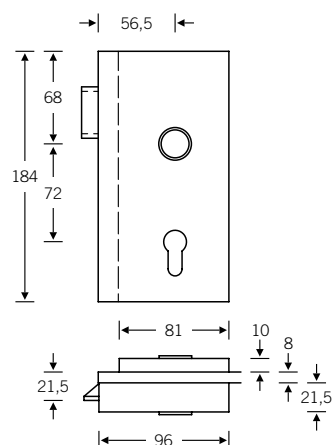

Please specify DIN door handing when ordering

\* Not in bronze

- ⊖ Female handles
  - ⊕ FSB ASL®
  - ⊖ FSB AGL®
  - ⊕ FS heavy-duty fitting
  - ⊕ EN 179 heavy-duty fitting
- For bearings, see page 52 ff.

# Fittings for glass doors

## Strike box

- Aluminium
- Stainless steel
- Bronze



13 4220

13 4220 045 (R) | 13 4220 055 (L)

Rectangular strike box  
for double-leaf glass doors  
matching glass door fittings  
13 4220 041 (R) | 13 4220 051 (L)  
13 4220 042 (R) | 13 4220 052 (L)

Pictured: DIN LH, opening inwards

6d

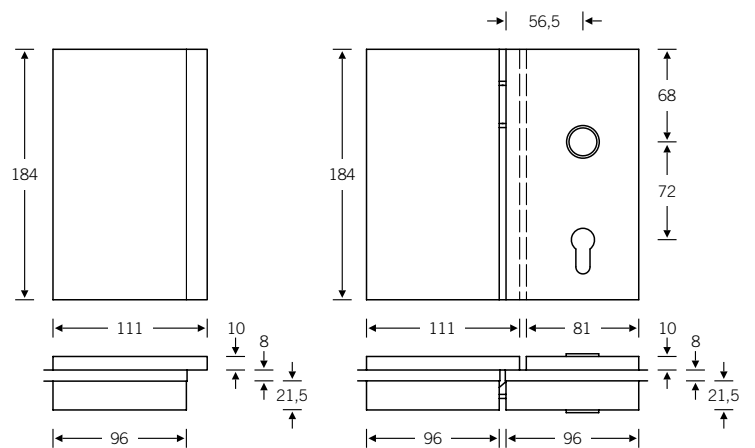

Please specify DIN door handing when ordering

# Fittings for glass doors

## Glass-door boxes for fire and panic doors

- Aluminium
- Stainless steel
- Bronze



13 4220 ■

Door thickness 24 mm

- ① 13 4220 09001 (R) | 13 4220 09002 (L)  
Fire safety variant
- ① 13 4220 09003 (R) | 13 4220 09004 (L)  
with APE panic function  
(lever/knob set)
- ① 13 4220 09005 (R) | 13 4220 09006 (L)  
with APD panic function  
(lever/lever set)

Door thickness 10 mm

- ① 13 4220 09015 (R) | 13 4220 09016 (L)  
Fire safety variant
- ① 13 4220 09007 (R) | 13 4220 09008 (L)  
with APD panic function  
(lever/lever set)
- ① 13 4220 09009 (R) | 13 4220 09010 (L)  
with APE panic function  
(lever/knob set)

Rectangular glass door fitting  
with heavy-duty glass door lock (DIN 18250,  
based on grade 4)

Fitted for profile cylinder (PC) with lifter  
assembly; bolt head as bright nickel-plated  
casting; fitted for installation of door hand-  
les with handle roses and FSB heavy-duty  
fittings with FSB AGL® bearing

Variant with square handle roses also  
available

Pictured: DIN RH, opening inwards

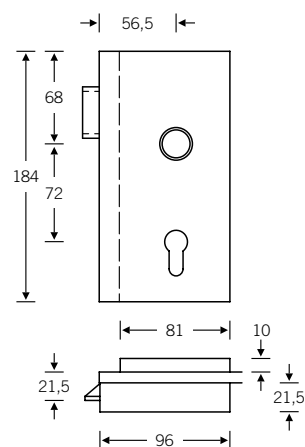

Please specify DIN door handing when  
ordering

- ① Female handles
  - ① FSB ASL®
  - ① FSB AGL®
  - ① FS heavy-duty fitting
  - ① EN 179 heavy-duty fitting
- For bearings, see page 52 ff.

# Fittings for glass doors

## Glass-door boxes

■ Aluminium  
■ Stainless steel  
■ Bronze



Model 13 4223 041



Model 13 4223 042

13 4223 ■ ■

- ⊖ 13 4223 041 (R) | 13 4223 051 (L)
- ⊕ 13 4223 042 (R) | 13 4223 052 (L)
- ⊖ 13 4223 042 (R) | 13 4223 052 (L)

Rectangular glass door fitting, round-cornered with heavy-duty glass door lock (DIN 18251-1, based on grade 4)

Profile cylinder (PC) 72 mm, 8 mm self-tightening follower in steel with polyamide retaining ring

Latch bolt in a combination of plastic/pressure die casting, acoustically attenuated

13 4223 041 (R) | 13 4223 051 (L)  
Fitted for profile cylinder (PC); bolt head as bright nickel-plated casting; handle bushing in GFR polyamide; can be combined with female handles

13 4223 042 (R) | 13 4223 052 (L)  
Fitted for profile cylinder (PC) with lifter assembly; bolt head as bright nickel-plated casting; pre-fitted for installation of door handles with handle roses and FSB ASL® bearing or FSB heavy-duty fitting with FSB AGL® bearing (also available in these two variants with square handle roses)

Pictured: DIN RH, opening inwards

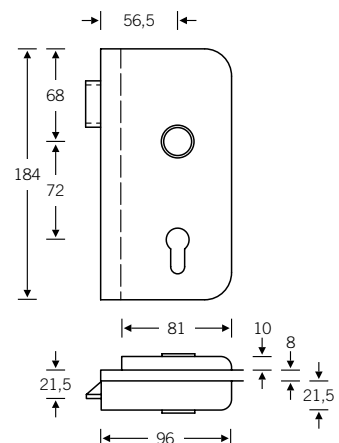

6d

Please specify DIN door handing when ordering



- ⊖ Female handles
  - ⊕ FSB ASL®
  - ⊖ FSB AGL®
  - ⊕ FS heavy-duty fitting
  - ⊖ EN 179 heavy-duty fitting
- For bearings, see page 52 ff.

# Fittings for glass doors

## Strike box

- Aluminium
- Stainless steel
- Bronze



13 4223  

13 4223 045 (R) | 13 4223 055 (L)

Rectangular strike box, round-cornered  
for double-leaf glass doors  
matching glass door fittings  
13 4223 041 (R) | 13 4223 051 (L)  
13 4223 042 (R) | 13 4223 052 (L)

Pictured: DIN LH, opening inwards

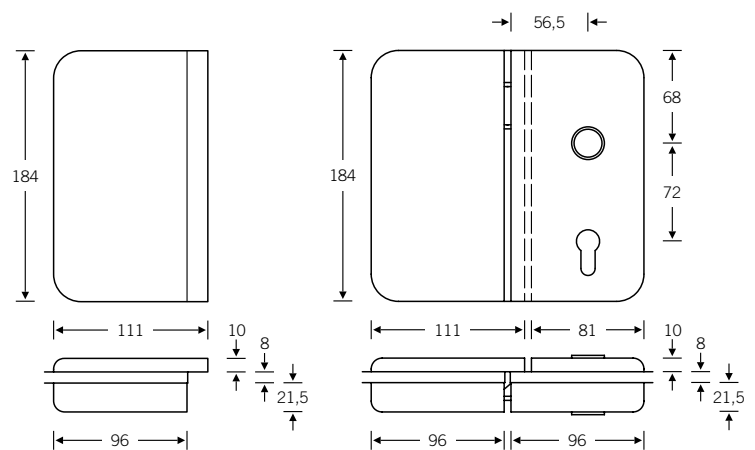

Please specify DIN door handing when ordering

# Fittings for glass doors

## Glass-door box

- Aluminium
- Stainless steel
- Bronze



13 4231

- ⊕ 13 4231 00001 (without PC keyway)
- ⊕ 13 4231 00010 (with PC keyway)

Latch bolt can be modified from right to left; cannot be combined with door handle models 1163, 1241, 1242, 1251 and 1254

Only available in Aluminium, Natural Colour, Anodised (FSB 0105) and Stainless Steel, Brushed Satin Matt (FSB 6204)

Pictured: DIN RH, opening inwards

6d

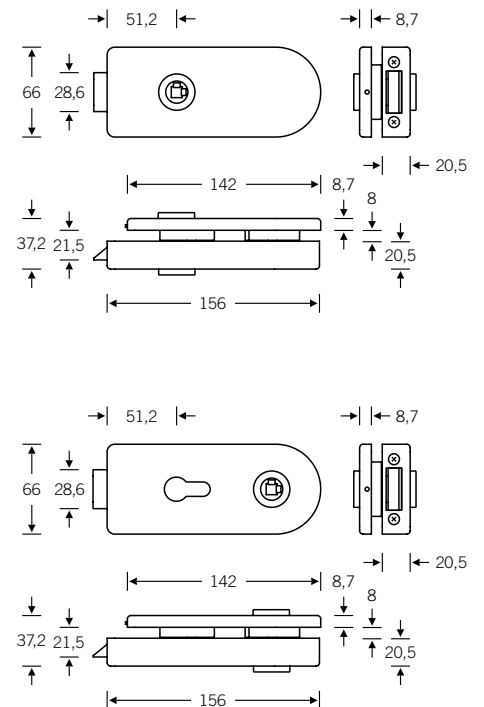

Please specify DIN door handing when ordering

- ⊕ Female handles
  - ⊕ FSB ASL®
  - ⊕ FSB AGL®
  - ⊕ FS heavy-duty fitting
  - ⊕ EN 179 heavy-duty fitting
- For bearings, see page 52 ff.





# Fittings for glass doors

## Strike box

- Aluminium
- Stainless steel
- Bronze



13 4231  

13 4231 01001



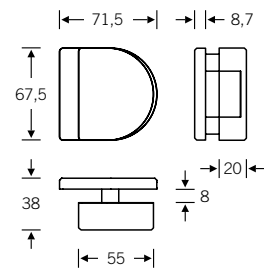

Semi-circle strike box  
matching glass door fitting 13 4231

Only available in Aluminium, Natural Colour,  
Anodised (FSB 0105) and Stainless Steel,  
Brushed Satin Matt (FSB 6204)

Pictured: DIN LH, opening inwards



Please specify DIN door handing when  
ordering

-  Female handles
  -  FSB ASL®
  -  FSB AGL®
  -  FS heavy-duty fitting
  -  EN 179 heavy-duty fitting
- For bearings, see page 52 ff.

# Fittings for glass doors

## Glass-door hinge

■ Aluminium  
■ Stainless steel  
■ Bronze



13 4232 ■

13 4232 00001

Glass-door hinge  
in matt chrome-plated steel



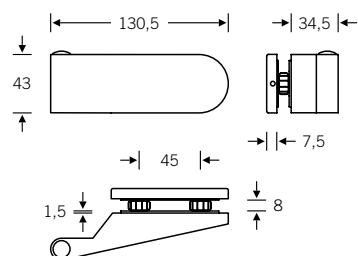

Only available in Aluminium, Natural Colour, Anodised (FSB 0105). Finish FSB 3427 (Aluminium, Anodised, in stainless steel look) is available for matching to stainless steel fittings.

Load capacity: 60 kg, 2 hinges  
90 kg, 3 hinges

6d



Please specify DIN door handing when ordering

-  Female handles
  -  FSB ASL®
  -  FSB AGL®
  -  FS heavy-duty fitting
  -  EN 179 heavy-duty fitting
- For bearings, see page 52 ff.

# Fittings for glass doors

## Angular glass-door hinge

- Aluminium
- Stainless steel
- Bronze



13 4228

VARIANT glass-door hinge  
in matt chrome-plated steel and stainless  
steel, with receiver

Matching glass door fittings from series  
13 4220 and 13 4224

Finishes:

- material matt chrome-plated steel only  
available in Aluminium, Natural Colour,  
Anodised
- material stainless steel only available in  
Brushed Satin Matt

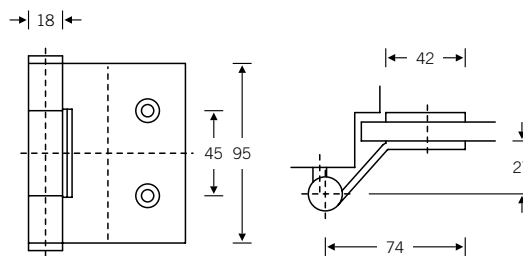

VARIANT heavy-duty hinges

13 4228 00101 for glass doors in rebated  
timber, steel or aluminium frames

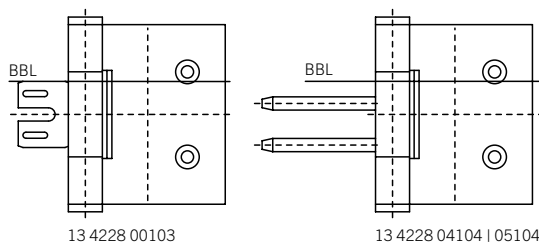
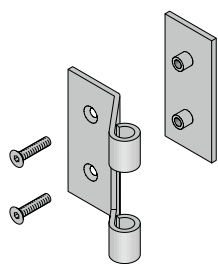
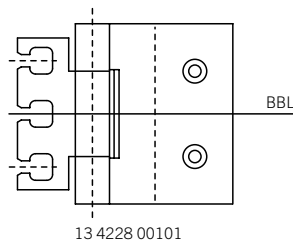

13 4228 00103 for glass doors in rebated  
steel frames

13 4228 04104 (R) | 13 4228 05104 (L)  
for glass doors in rebated timber-casing  
and block frames

Load capacity:

60 kg, 2 hinges  
90 kg, 3 hinges

Glass-door hinges pre-fitted for glass  
thicknesses 8 and 10 mm

# Fittings for glass doors

## Round glass-door hinge

- Aluminium
- Stainless steel
- Bronze



13 4227

VARIANT glass-door hinge in matt chrome-plated steel and stainless steel, with receiver

Matching glass door fittings from series 13 4223

Finishes:

- material matt chrome-plated steel only available in Aluminium, Natural Colour, Anodised
- material stainless steel only available in Brushed Satin Matt

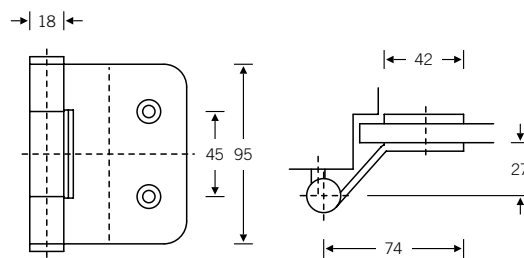

VARIANT heavy-duty hinges

6d

13 4227 00101 for glass doors in rebated timber, steel or aluminium frames

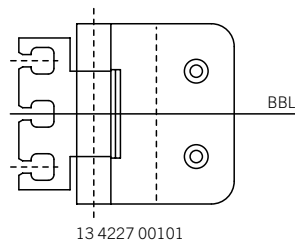

13 4227 00103 for glass doors in rebated steel frames

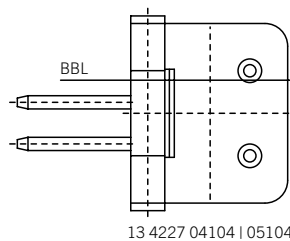
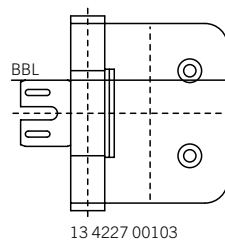
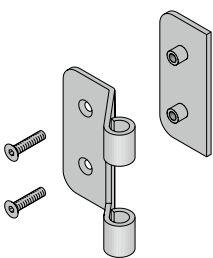

13 4227 04104 (R) | 13 4227 05104 (L) for glass doors in rebated timber-casing and block frames

Load capacity:

60 kg, 2 hinges  
90 kg, 3 hinges

Glass-door hinges pre-fitted for glass thicknesses 8 and 10 mm

# Fittings for glass doors

## Doorknobs

- Aluminium
- Stainless steel
- Bronze



23 0802

23 0802 00007

Aluminium X = 77 mm  
Stainless steel X = 73 mm  
Bronze X = 72 mm

Drill hole  $\varnothing$  13 mm

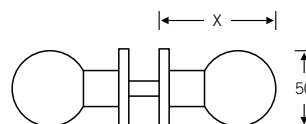

23 0844

23 0844 00007

Design: Jasper Morrison

Drill hole  $\varnothing$  13 mm

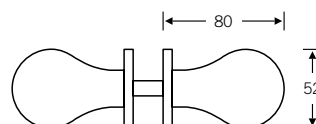

### Fixed knobs

With glass doors, doorknobs are fitted directly as a rule and are not free to rotate. No locks are fitted. Sets are assembled by fitting the doorknobs to either end of an 8 mm square spindle (for two female handles).

# Fittings for glass doors

## Doorknobs

■ Aluminium  
■ Stainless steel  
■ Bronze



23 0828

23 0828 00007

Drill hole  $\varnothing$  13 mm

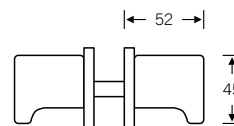

23 0829

23 0829 00007

Aluminium  $\varnothing$  = 50 mm  
Stainless steel  $\varnothing$  = 55 mm  
Bronze  $\varnothing$  = 50 mm

Drill hole  $\varnothing$  13 mm

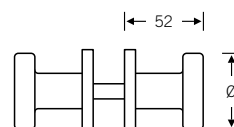

6d

Fixed knobs

With glass doors, doorknobs are fitted directly as a rule and are not free to rotate. No locks are fitted. Sets are assembled by fitting the doorknobs to either end of an 8 mm square spindle (for two female handles).

# Fittings for glass doors

## Sliding door handles

■ Aluminium  
■ Stainless steel  
■ Bronze



13 4256 ■ ■

| Product code  | B     | A     |
|---------------|-------|-------|
| 13 4256 00100 | 8 mm  | 16 mm |
| 13 4256 00200 | 10 mm | 18 mm |
| 13 4256 00300 | 12 mm | 20 mm |

Glass thickness = B; total thickness = A

Open variant

Pair for either side of the door  
Glass cut-out  $\varnothing$  70 mm

No adhesives required; back-to-back fixing with countersunk screws  $\varnothing$  3.9 mm, included in scope of delivery

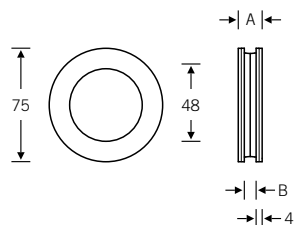

13 4256 ■ ■

| Product code  | B     | A     |
|---------------|-------|-------|
| 13 4256 00101 | 8 mm  | 20 mm |
| 13 4256 00201 | 10 mm | 22 mm |
| 13 4256 00301 | 12 mm | 24 mm |

Glass thickness = B; total thickness = A

Enclosed variant

Pair for either side of the door  
Glass cut-out  $\varnothing$  70 mm

No adhesives required; back-to-back fixing with countersunk screws  $\varnothing$  3.9 mm, included in scope of delivery

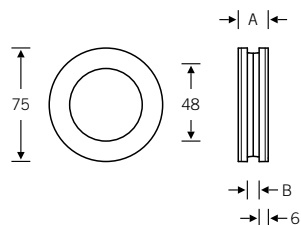

# Fittings for glass doors

## Sliding door handle and door holder

- Aluminium
- Stainless steel
- Bronze



13 4257 ■ ■

Enclosed variant

Pair for either side of the door  
Glass cut-out 75 mm × 75 mm

No adhesives required; back-to-back fixing with countersunk screws  $\varnothing$  3.9 mm, included in scope of delivery

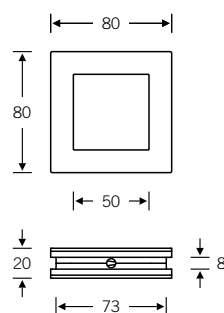

13 4230 ■

| Product code | B     | A     |
|--------------|-------|-------|
| 13 4230 000  | 8 mm  | 27 mm |
| 13 4230 010  | 10 mm | 29 mm |
| 13 4230 012  | 12 mm | 31 mm |

Glass thickness = B; total thickness = A

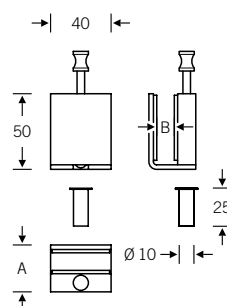

6d





521 **Technical information**  
Fittings for glass doors

# Technical information

## Glass door measurements pursuant to DIN 18101

### Glass cut-outs for series 13 4220 – 13 4224 Profile cylinder

The glass door fittings and strike boxes are pre-fitted: series 13 4220 and 13 4223 for glass door thicknesses 8 and 10 mm, and series 13 4224 for 8 mm.

Profile cylinders with lengths of 25/25 mm or 27.5/27.5 mm are recommended owing to the small projection achieved. Profile cylinders 25/25 mm must be checked on a case-by-case basis to ensure they are compatible with the locking system.

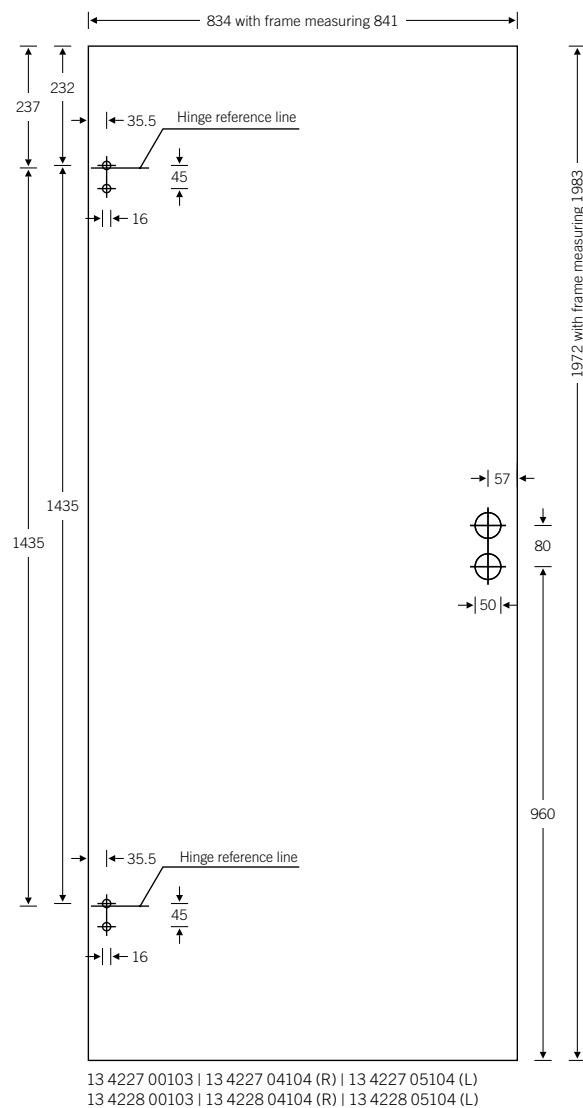
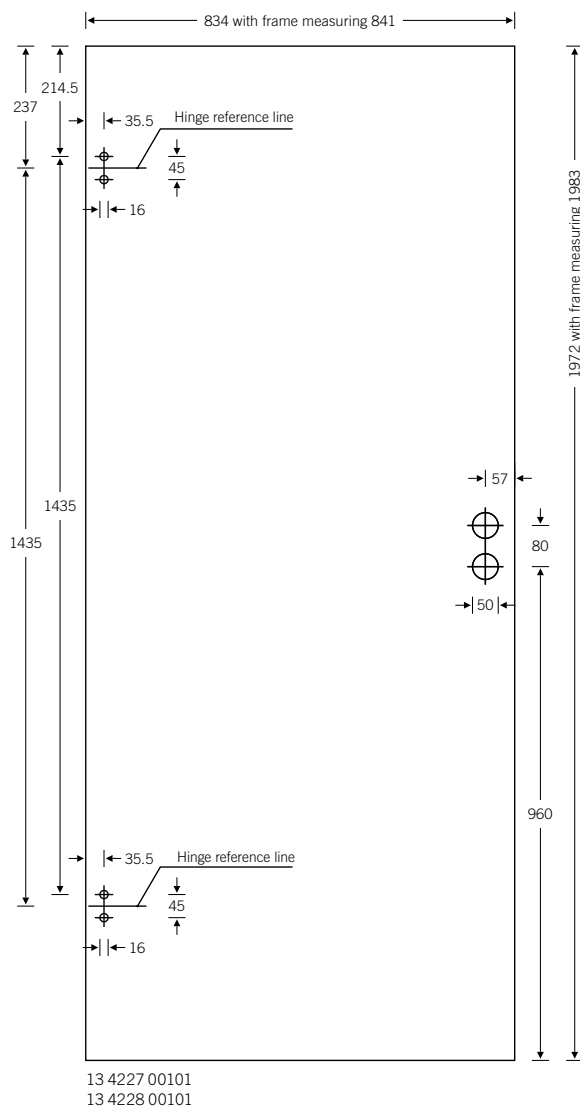

|                                |               |               |                |
|--------------------------------|---------------|---------------|----------------|
| Approximate carcass dimensions | 750 × 2000 mm | 875 × 2000 mm | 1000 × 2000 mm |
| Frame rebate dimensions        | 716 × 1983 mm | 841 × 1983 mm | 966 × 1983 mm  |
| Standard glass dimensions      | 709 × 1972 mm | 834 × 1972 mm | 959 × 1972 mm  |

|                                |               |               |                |
|--------------------------------|---------------|---------------|----------------|
| Approximate carcass dimensions | 750 × 2125 mm | 875 × 2125 mm | 1000 × 2125 mm |
| Frame rebate dimensions        | 716 × 2108 mm | 841 × 2108 mm | 966 × 2108 mm  |
| Standard glass dimensions      | 709 × 2097 mm | 834 × 2097 mm | 959 × 2097 mm  |

# Technical information

## Glass door measurements pursuant to DIN 18101

### Glass cut-outs for series 13 4231

The glass door fittings and strike boxes are pre-fitted for glass thickness 8 mm.

### Profile cylinder

Profile cylinders with lengths of 25/25 mm or 27.5/27.5 mm are recommended owing to the small projection achieved. Profile cylinders 25/25 mm must be checked on a case-by-case basis to ensure they are compatible with the locking system.

Active leaf:

Inactive leaf:

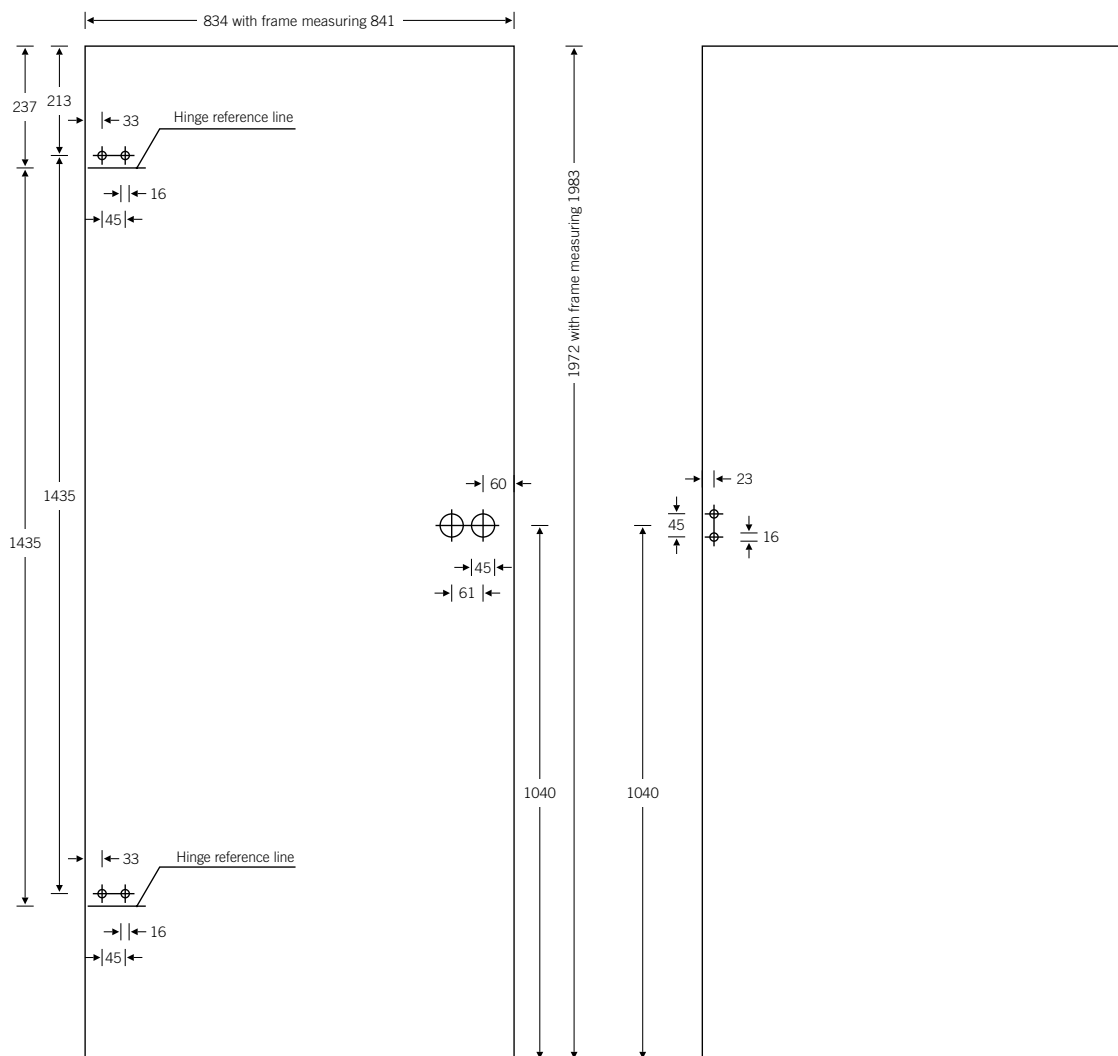

13 4232 00001

|                                |               |               |                |
|--------------------------------|---------------|---------------|----------------|
| Approximate carcass dimensions | 750 × 2000 mm | 875 × 2000 mm | 1000 × 2000 mm |
| Frame rebate dimensions        | 716 × 1983 mm | 841 × 1983 mm | 966 × 1983 mm  |
| Standard glass dimensions      | 709 × 1972 mm | 834 × 1972 mm | 959 × 1972 mm  |

|                                |               |               |                |
|--------------------------------|---------------|---------------|----------------|
| Approximate carcass dimensions | 750 × 2125 mm | 875 × 2125 mm | 1000 × 2125 mm |
| Frame rebate dimensions        | 716 × 2108 mm | 841 × 2108 mm | 966 × 2108 mm  |
| Standard glass dimensions      | 709 × 2097 mm | 834 × 2097 mm | 959 × 2097 mm  |

# Technical information

## Receivers for 13 4227 and 13 4228

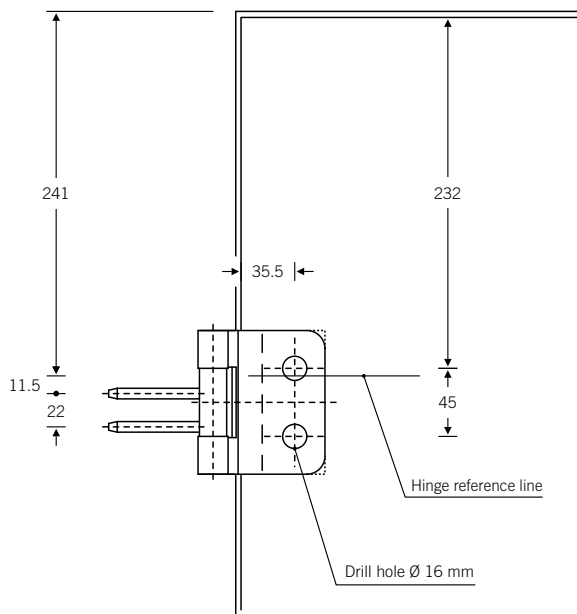
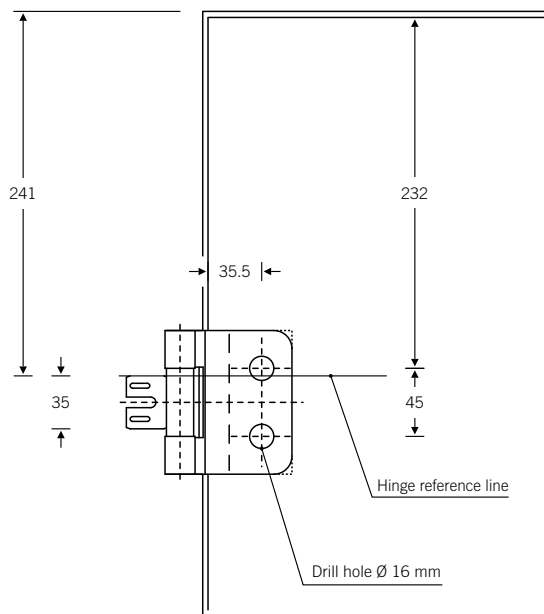
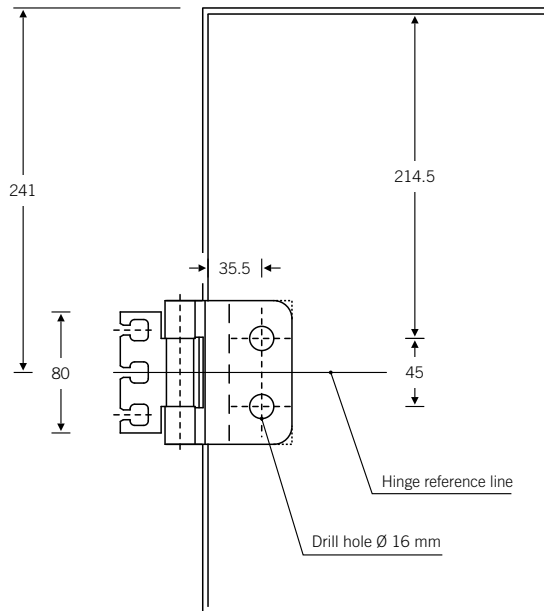

Receivers and their position relative to the hinge reference line also determine the positioning of drill holes in the glass door. This should be taken into consideration especially in the case of FSB heavy-duty hinges 13 4227 00101 and 13 4228 00101.

# Technical information

## Frame connection dimensions for 13 4227 and 13 4228

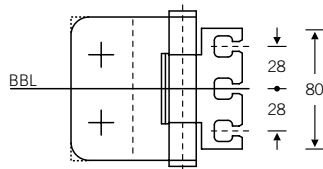

13 4227 00101 (round)  
13 4228 00101 (angular)

### VARIANT heavy-duty hinge for glass doors in rebated timber, steel or aluminium frames

- Designed for wholly glazed doors with standard vertical drill hole layout
  - For glass thicknesses 8 and 10 mm
  - Non-twist threaded pin
  - Concealed, maintenance-free axial/radial sliding bearing
- Can be combined with receiver:
 

|                      |            |
|----------------------|------------|
| for block frames     | VX 7501 3D |
| for casing frames    | VX 7502 3D |
| for block frames     | VX 7505 3D |
| for steel frames     | VX 7611 3D |
|                      | VX 7612 3D |
| for aluminium frames | VX 7521 3D |
  - Non-handed

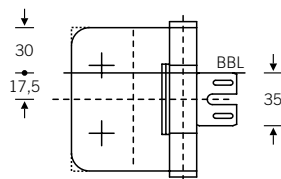

13 4227 00103 (round)  
13 4228 00103 (angular)

### VARIANT heavy-duty hinge for glass doors in rebated steel frames

- Designed for wholly glazed doors with standard vertical drill hole layout
- For glass thicknesses 8 and 10 mm
- For receiver V 8600 or V 8610
- Non-handed

6d

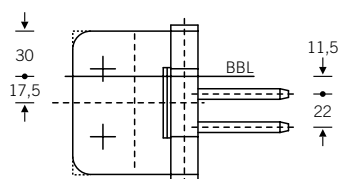

13 4227 04104 (R) | 05104 (L) | (round)  
13 4228 04104 (R) | 05104 (L) | (angular)

### VARIANT heavy-duty hinge for glass doors in rebated timber-casing and block frames

- Designed for wholly glazed doors with standard vertical drill hole layout
- For glass thicknesses 8 and 10 mm
- For receivers from series V 3600, V 3610, V 3630, V 3650, V 3690 and clamping block V 3604 or V 3607
- DIN door handing must be specified

Further information about hinges, receivers, frame fixing elements, etc. can be found in the latest SIMONSWERK manual.